



SPECIFICATION FEATURE:

SEALEAD DIE-CASTING PROFILE FOR OUTDOOR APPLICATIONS

POLYCARBONATE OPTICAL LENS WITH UV STABILIZER

BUILD-IN UL CLASS 2 DRIVER, OPTIONAL FOR PHOTOCELL

EASY INSTALLATION, CONTRACTOR-FRIENDLY DESIGN

135W

INPUT VOLTAGE	110 - 277 VAC / 480 VAC
CRI	>70
LUMEN PER WATT	120 LM/W
AVAILABLE CCT	4000K,5000K
LIFE SPAN	50,000 HOURS
OPERATION TEMPERATURE	-40°F ~ 104°F
LM/W	16,200
MOUNTING OPTIONS	DIRECT MOUNT

ORDERING OPTIONS:

135W

EXAMPLE: LEDWP 135W 50K 277V

LEDWP	90W	50K	[BLANK]	[BLANK]	[BLANK]
SERIES LEDWP	RATED WATTAGE 135W 135 WATT	COLOR TEMP 40K 4000 KELVIN 50K 5000 KELVIN	INPUT VOLTAGE BLANK 110 - 277 VAC HV 480 VAC	FINISHING BLANK DARK BRONZE WH WHITE	OPTIONS -PC TWIST LOCK PHOTOCELL -MS MOTION SENSOR -EB EMERGENCY BATTERY

DIMENSIONS:

135W

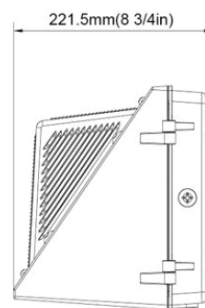
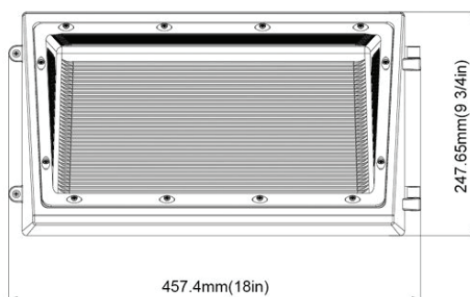

INSTALLATION:

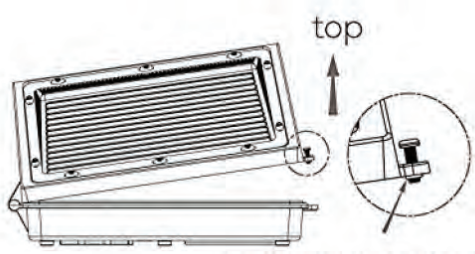

loosen screws and remove the front part

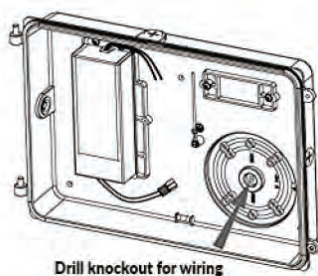

Drill knockout for wiring

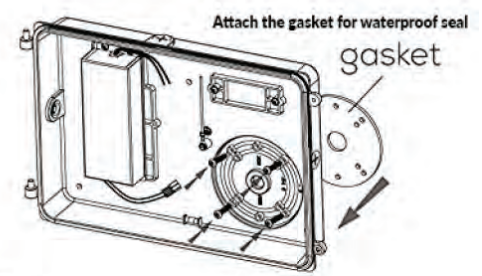

Attach the gasket for waterproof seal

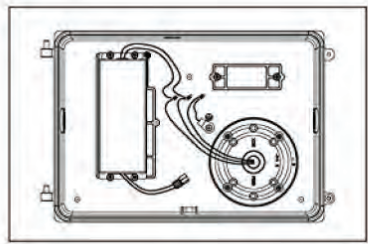

Follow the instruction for wiring
WIRE CONNECTION

- Black ———— ○ ———— Line
- White ———— ○ ———— Neutral
- Green/Yellow Green ———— ○ ———— Ground

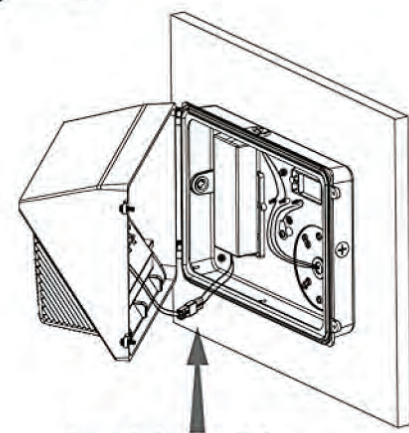

Connect the front part with the power