

SPECIFICATION FEATURE:

SEALED DIE-CASTING PROFILE FOR INDOOR AND OUTDOOR APPLICATIONS

LUMEN OUTPUT FOR 45 WATT IS 4,850 AND LUMEN OUTPUT FOR 60 WATT IS 6,150

EXTERNAL BATTERY BACKUP AND MOTION SENSOR OPTIONS

RUGGED DIE-CAST ALUMINUM HOUSING

IP65, DUST-TIGHT SEALED PROTECTION, AND PROTECTION FROM WATER PROJECTED WITH NOZZLE.

45 WATT

INPUT VOLTAGE	110-277VAC
CRI	> 75
LUMEN PER WATT	> 117 LM/W
AVAILABLE CCT	4000K,5000K
LIFE SPAN	50,000 HOURS
OPERATION TYPE	- 40F - 104F
BEAM ANGLE	120
MOUNTING OPTIONS	SURFACE MOUNT, 3/4 IN PRE-THREAD HOLE

60 WATT

INPUT VOLTAGE	110-277VAC
CRI	> 75
LUMEN PER WATT	> 117 LM/W
AVAILABLE CCT	4000K,5000K
LIFE SPAN	50,000 HOURS
OPERATION TYPE	- 40F - 104F
BEAM ANGLE	120
MOUNTING OPTIONS	SURFACE MOUNT, 3/4 IN PRE-THREAD HOLE

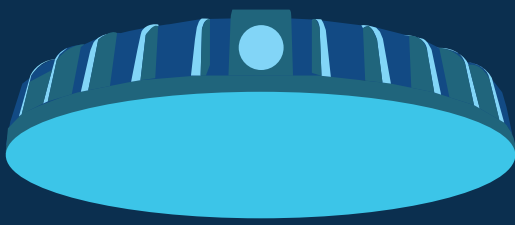

ORDERING OPTIONS:

EXAMPLE : LEDRCNP 45W 50K

45W - 60W

LEDRCNP	45W	50K	-[BLANK]	-[BLANK]	F	-[BLANK]
SERIES LEDRCNP	RATED WATTAGE 45W 45 WATT 60W 60WATT	COLOR TEMP 40K 4000KELVIN 50K 5000KELVIN	INPUT VOLTAGE BLANK 110 - 277 VAC	FINISHING BLANK DARK BRONZE WH WHITE	LENS BLANK -CLEAR LENS	OPTIONS BLANK - WITHOUT SENSOR MS - WITH MOTIIONG SENSOR EB - EMERGENCY BATTERY PC - PHOTOCELL

DIMENSIONS:

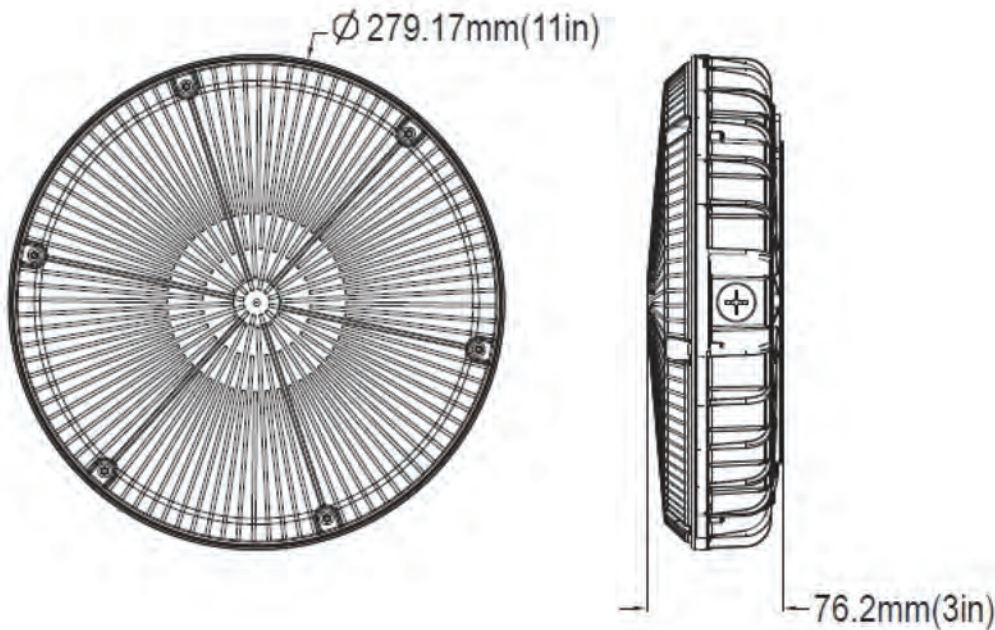

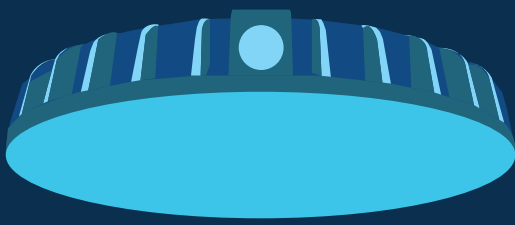

PHOTOMETRIC:

General

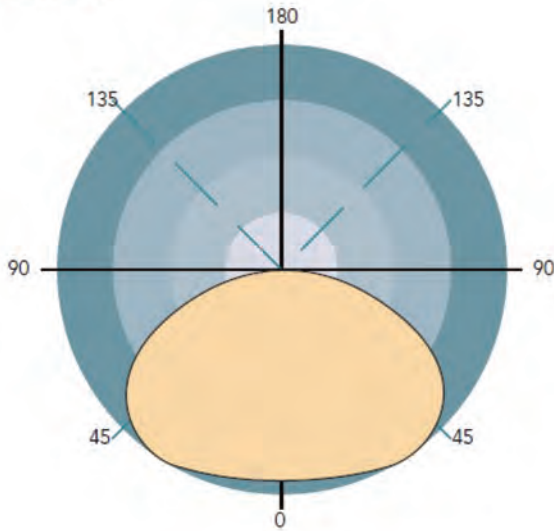

Parking Garage

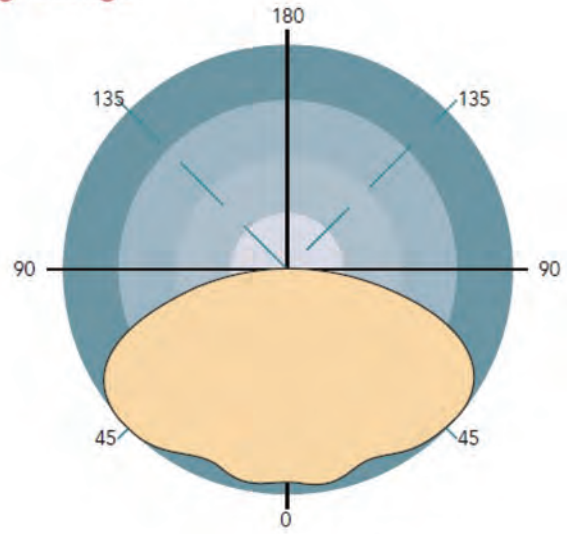

INSTALLATION:

1. Surface Mounted with J-box

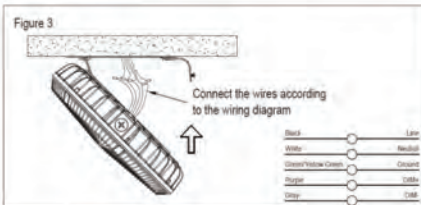
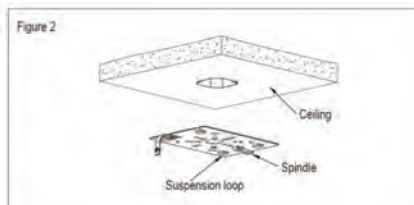
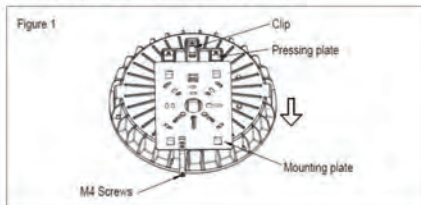

2. Pendent with 3/4 inch Conduit

