



Series E, F, G, H



Series B, C, D



Series A

LED Wall Pack Light



- Garden
- Hotel
- Hospital
- Factory
- Warehouse outdoor wall
- Airport
- Passageway



- Lumen Output 100~140 lumens/W
- CRI more than 70~80
- IP 65 water-proof
- Input voltage is AC90-305V
- 50/60Hz frequency
- Reduces energy consumption up to 60%.
- 5 years warranty
- Surface mounting installation
- Suitable for wet location
- UL& cUL 1598 certificated
- Phillips LED Chips
- High quality driver



Application

Parking Lots and Apartments, Warehouses and Factories, College Campuses and Schools.

Wall Pack series is the ideal choice for industrial zone lighting in a variety of settings, such as entryways, parking lots, warehouses, barns, sheds, and more. With light output up to 12,000 lumens, these fixtures will give the light you need for your application, as well as save you up to 60% on your energy bill. All of our Wall Packs are IP65 rated to stand up to the elements without the risk of damage, shock, or fire.

Our product selected high quality driver and LED chips to ensure their stability, otherwise aluminum housing and fins heat sink provide excellent heat dissipation. 5 years warranty gives you a no risk of damaging protection.

Ordering Guide

WP	115/20/40/60/80/100W	WXYZ
Wall Pack light	Wattage	T index A~H Series X index dimming options Y index CCT(27,30...50) Z index H(Half Cut) or F(Full Cut) G(general beam angle)

Product Number	Power Consumption (W)	Dimensions L*W*H(Inch)	Fixture Luminous Flux(lm)	Fixture Efficacy (Lm/W)	Color Temperature (K)
WP-13W AXYG	13	9.1"x6.3"x2.8"	1,300~1,690	100~130	2700K-6500K
WP-20W AXYG	20	9.1"x6.3"x2.8"	2,000~2,600	100~130	2700K-6500K

Photometric Data

Rated Power	13/20
Input Voltage	90-305VAC
Frequency	50 / 60 Hz
Power Factor	>0.9
Beam Angle	92.5°
CRI	≥ 80
Operating Temperature	-30°C to 45°C

Dimension

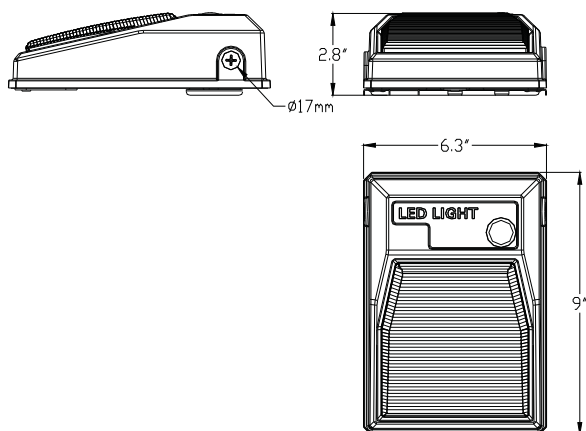

Light Distribution Pattern

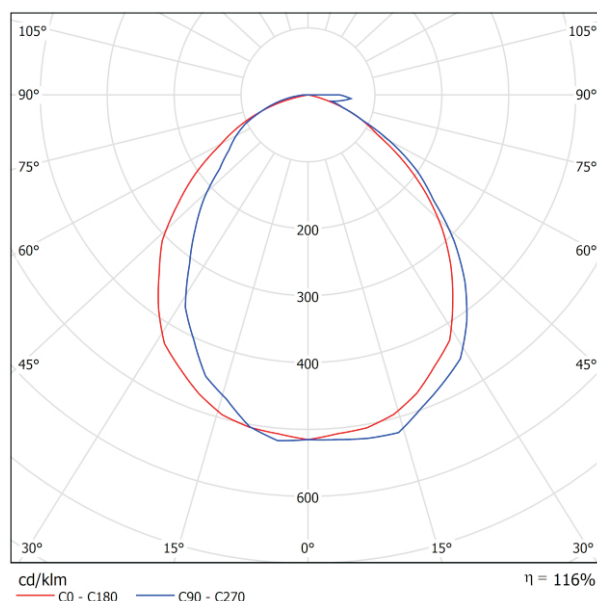

LED Wall Pack Light Series B~D

Technical Details and Photometric

Product Number	Power Consumption (W)	Dimensions L*W*H(Inch)	Fixture Luminous Flux(lm)	Fixture Efficacy (Lm/W)	Color Temperature (K)
WP-45W BXYF	45	10"x7.1"x4.7"	4,500~5,850	100~130	2700K-6500K
WP-70W DXYF	70	11"x8.1"x4.7"	7,000~9,100	100~130	2700K-6500K

Dimension

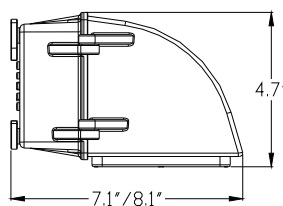
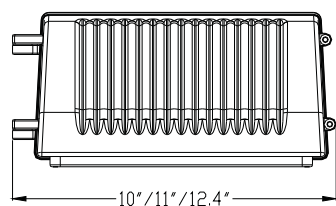

Light Distribution Pattern

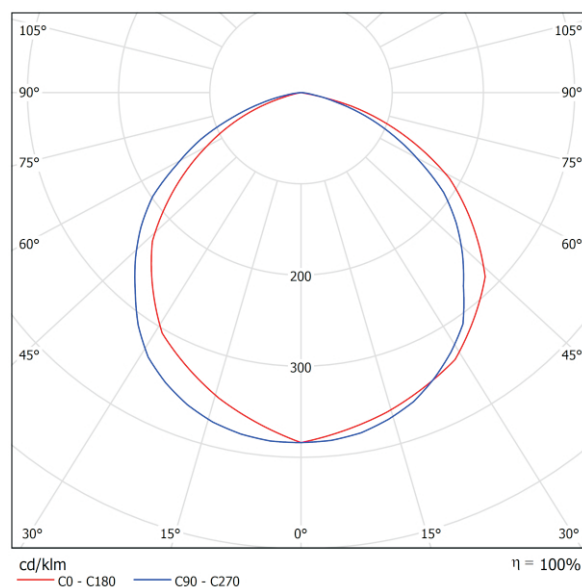

Photometric Data

Rated Power	40/75W
Input Voltage	90-305VAC
Frequency	50 / 60 Hz
Power Factor	>0.9
Beam Angle	103°
CRI	≥ 80
Operating Temperature	-30°C to 45°C

Product Number	Power Consumption (W)	Dimensions L*W*H(Inch)	Fixture Luminous Flux(lm)	Fixture Efficacy (Lm/W)	Color Temperature (K)
WP-40W EXYH	40	9.5"x6"x6"	4,000~5,200	100~130	2700K-6500K
WP-60W FXYH	60	10.7"x6.3"x6"	6,000~7,800	100~130	2700K-6500K
WP-80W GXYH	80	15"x7.5"x7.2"	8,000~10,400	100~130	2700K-6500K
WP-100W HXYH	100	15"x7.5"x7.2"	10,000~13,000	100~130	2700K-6500K

Dimension

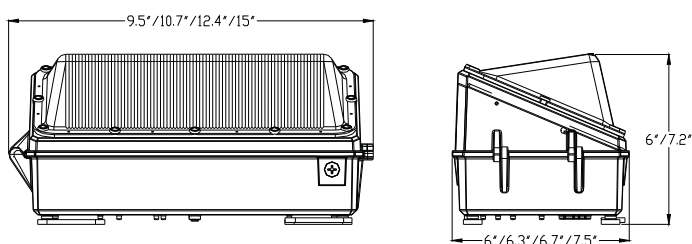

Light Distribution Pattern

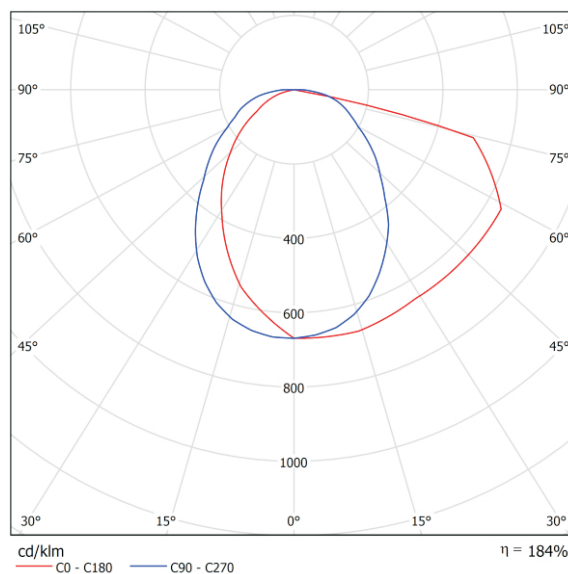

Photometric Data

Rated Power	40/60/80/100W
Input Voltage	90-305VAC
Frequency	50 / 60 Hz
Power Factor	>0.9
Beam Angle	105°
CRI	≥ 80
Operating Temperature	-30°C to 45°C